













## ASSEMBLE INSTRUCTION ITEM NO :5905

**\*\* Thank you for purchasing quality product.Be sure to check all packing material carefully for small parts that may have came loose inside the carton during shipment.**  
**Note:place all wooden parts on a clean and smooth surface such as a rug or carpet to avoid scatching the product .Kindly follow the assembly instructions by step.**  
**Do not tighten all screws and bolts until the chair is fully assemble.**

HARDWARE LIST				PARTS IDENTIFICATION			
1	Ø 1/4"X50mm		12PCS	A	CHAIR BACK		1PCS
2	Ø 1/4"X10.5mm		12PCS	B	SIDE FRAME (LEFT&RIGHT)		2PCS
3	Ø 1/4"X12.5mm		12PCS	C	FRONT RAIL		1PCS
4	M4		1PCS	D	FRONT STRETCHER		1PCS
5	Ø 13.5mmX8mm		8PCS	E	SUPPORT SEAT		2PCS
6	Screw #4x35		6Pcs	F	BOTTOM LEG		2PCS
				G	SEAT		1PCS

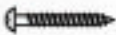

### STEP 1

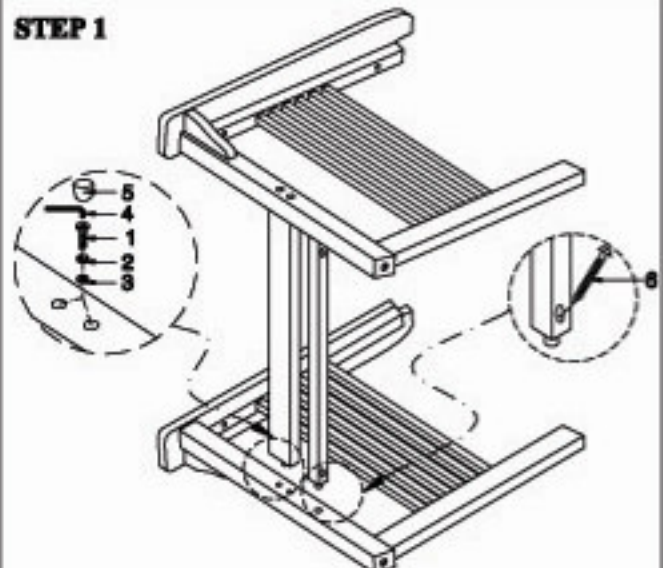

# ASSEMBLE INSTRUCTION

## ITEM NO :5905

**STEP 2**

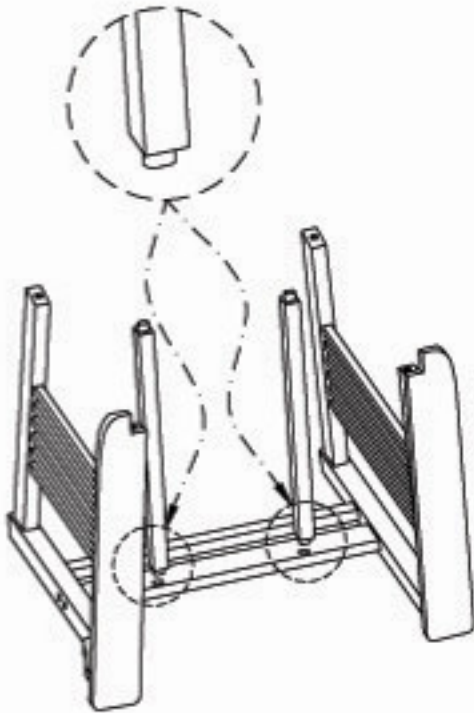

**STEP 3**

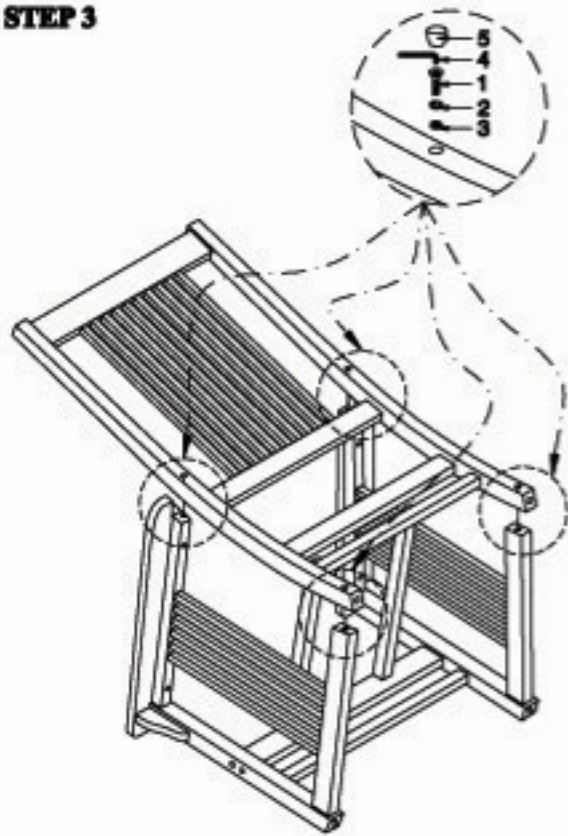

**STEP 4**

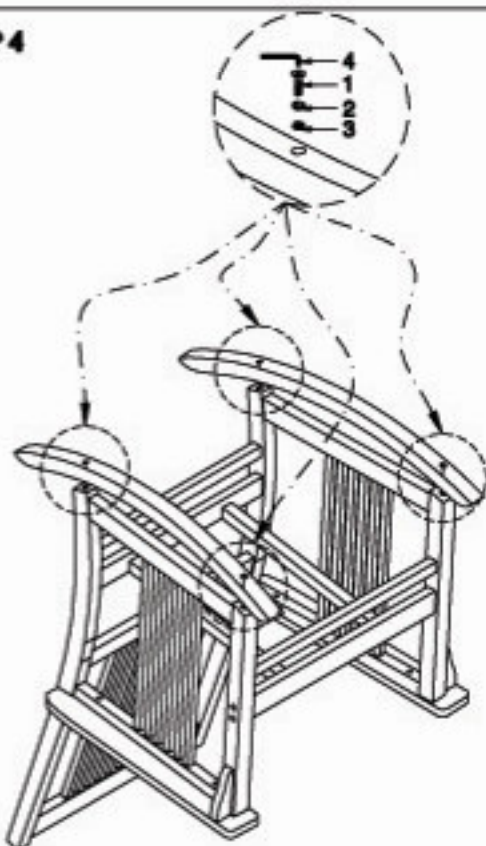

**STEP 5**

